



ALPICAIR



Owner's Manual

Original Instructions

Commercial Air Conditioners

Multi Variable Air Conditioners

Compact Cassette Type Indoor Unit

Models:

ACCOMI-15VRDC1D

ACCOMI-18VRDC1D

ACCOMI-22VRDC1D

ACCOMI-28VRDC1D

ACCOMI-36VRDC1D

ACCOMI-45VRDC1D

ACCOMI-50VRDC1D

ACCOMI-56VRDC1D

Thank you for choosing commercial air conditioners. Please read this Owner's Manual carefully before operation and retain it for future reference.

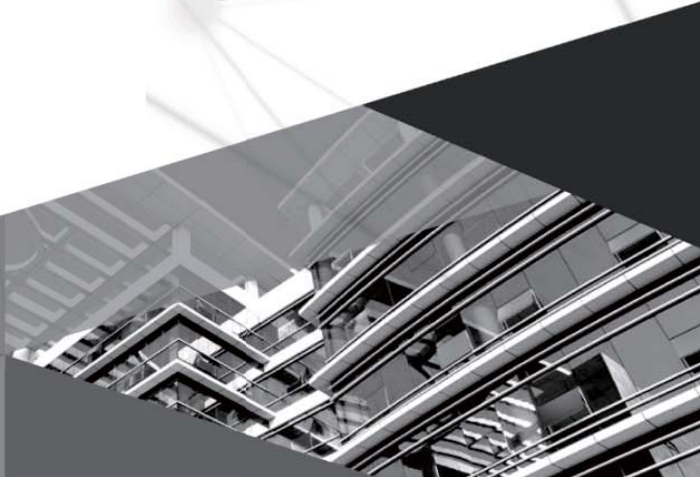

To Users

Thank you for selecting AlpicAir's product. Please read this instruction manual carefully before installing and using the product, so as to master and correctly use the product. In order to guide you to correctly install and use our product and achieve expected operating effect, we hereby instruct as below:

- (1) This appliance can be used by children aged from 8 years and above and persons with reduced physical sensory or mental capabilities or lack of experience and knowledge if they have been given supervision or instruction concerning use of the appliance in a safe way and understand the hazards involved. Children shall not play with the appliance. Cleaning and user maintenance shall not be made by children without supervision.
- (2) In order to ensure reliability of product, the product may consume some power under stand-by status for maintaining normal communication of system and preheating refrigerant and lubricant. If the product is not to be used for long, cut off the power supply; please energize and preheat the unit in advance before reusing it.
- (3) Please properly select the model according to actual using environment, otherwise it may impact the using convenience.
- (4) This product has gone through strict inspection and operational test before leaving the factory. In order to avoid damage due to improper disassembly and inspection, which may impact the normal operation of unit, please do not disassemble the unit by yourself. You can contact with the special maintenance center of our company if necessary.
- (5) When the product is faulted and cannot be operated, please contact with our maintenance center as soon as possible by providing the following information.
 - 1) Contents of nameplate of product (model, cooling/heating capacity, product No., ex-factory date).
 - 2) Malfunction status (specify the situations before and after the error occurs).
- (6) All the illustrations and information in the instruction manual are only for reference. In order to make the product better, we will continuously conduct improvement and innovation. We have the right to make necessary revision to the product from time to time due to the reason of sales or production, and reserve the right to revise the contents without further notice.
- (7) The final right to interpret for this instruction manual belongs to AlpicAir.

Exception Clauses

Manufacturer will bear no responsibilities when personal injury or property loss is caused by the following reasons:

- (1) Damage the product due to improper use or misuse of the product;
- (2) Alter, change, maintain or use the product with other equipment without abiding by the instruction manual of manufacturer;
- (3) After verification, the defect of product is directly caused by corrosive gas;
- (4) After verification, defects are due to improper operation during transportation of product;
- (5) Operate, repair, maintain the unit without abiding by instruction manual or related regulations;
- (6) After verification, the problem or dispute is caused by the quality specification or performance of parts and components that produced by other manufacturers;
- (7) The damage is caused by natural calamities, bad using environment or force majeure.

Contents

1 Safety Notices (Please be sure to abide)	1
2 Product Introduction	4
2.1 Names of Key Components	4
2.2 Rated Working Condition	4
3 Preparations for Installation	4
3.1 Standard Fittings	4
3.2 Installation Position Selection	5
3.3 Requirements of Communication Wire Selection	6
3.4 Wiring Requirements	7
4 Installation Instructions	8
4.1 Indoor unit installation.....	8
4.2 Refrigerant Pipe Connection.....	10
4.3 Drainage Pipe Installation and Drainage System Testing	11
4.4 Panel Installation	14
4.5 Installation of Wired Controller	16
5 Wiring Work	16
5.1 Connection of Wire and Patch Board Terminal.....	17
5.2 Power Cord Connection.....	17
5.3 Connection of Communication Wire between Indoor Unit and Outdoor Unit (or indoor unit)	18
5.4 Connection of Communication Wire for Wired Controller	19
5.5 Wiring Instructions of Wired Controller and Indoor Units Network	19
6 Routine Maintenance	20
6.1 Cleaning of Filter	21
6.2 Maintenance before the Seasonal Use	21
6.3 Maintenance after the Seasonal Use	21
7 Table of Error Codes for Indoor Unit	21
8 Troubleshooting	22

1 Safety Notices (Please be sure to abide)



WARNING! If not abide strictly, it may cause severe damage to the unit or the people.



NOTICE! If not abide strictly, it may cause slight or medium damage to the unit or the people.



This sign indicates that the operation must be prohibited. Improper operation may cause severe damage or death to people.



This sign indicates that the items must be observed. Improper operation may cause damage to people or property.



WARNING!

This product can't be installed at corrosive, inflammable or explosive environment or the place with special requirements, such as a kitchen. Otherwise, it will affect the normal operation or shorten the service life of the unit, or even cause fire hazard or serious injury. As for above special places, please adopt special air conditioner with anti-corrosive or anti-explosion function.















This Multi VRF System shall only be connected to an appliance suitable for the same refrigerant.

All units in Manual Cover is a partial unit, complying with partial unit of IEC 60335-2-40:2018, and must only be connected to other units that have been confirmed as complying to corresponding partial unit requirements of this international standard.



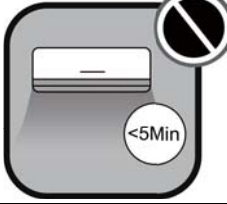

The electrical interface shall comply with electrical security requirement, voltage shall be 220-240V~50Hz or 208-230V~60Hz, current shall be referred to the table of "Dimension of power cord and capacity of air switch" in Section 3.4, and safety class of construction is I.

	<p>Please install the unit according to instructions in this manual. Read this manual carefully before starting up or checking the machine.</p>		<p>Installation should be performed by dealer or qualified technicians. Do not install the product by yourself. Improper installation may result in water leakage, electric shock or fire hazard.</p>
	<p>Make sure the local power supply is in accordance with units before installation, and check the power supply carefully.</p>		<p>This air conditioner must be properly grounded through the receptacle to avoid electric shock. The grounding wire shouldn't be connected with gas pipe, water pipe, lightning arrester or telephone line.</p>

Multi Variable Air Conditioners Compact Cassette Type Indoor Unit

 <p>Dedicated components</p>	<p>Please use specialized accessories or parts to carry out installation, or water leakage, electric shock, fire hazard may resulted.</p>		<p>R410A refrigerant can produce poisonous gas once it meets fire, so please ventilate the room immediately if refrigerant leaks out during installation.</p>
 <p>Dedicated</p>	<p>Diameter of power cord must be large enough. Damaged power cord and connecting wire must be replaced by specialized electric cable.</p>		<p>After the power cord is connected, please install the cover of electric box to avoid danger.</p>
 <p>N₂</p>	<p>Nitrogen must be charged according to technical requirements.</p>		<p>Short circuit is forbidden. Do not cancel the pressure switch in case the unit may be damaged.</p>
	<p>For units with wired controller, do not connect power supply until the wired controller is well installed. Otherwise, the wired controller cannot be used.</p>		<p>When the installation is finished, please check and make sure the drain pipe, pipeline and electric wire are all well connected in order to avoid water leakage, refrigerant leakage, electric shock or fire hazard.</p>
	<p>Do not extend fingers or objects into air outlet or air return grille.</p>		<p>If you use gas heater or petroleum heater in the same room, please open the door or window to maintain good air circulation in case the room may lack of oxygen.</p>
	<p>Never start or stop the air conditioner by inserting or removing the power cord.</p>	 <p><5Min</p>	<p>Do not turn off the air conditioner until it runs for at least 5 minutes. Otherwise, oil-return of the compressor will be affected.</p>
	<p>Children are not allowed to operate the air conditioner.</p>		<p>Do not operate the air conditioner with wet hands.</p>
	<p>Please turn the unit off and unplug your air conditioner before cleaning. Otherwise, it may cause electric shock or personal injury.</p>		<p>Do not spray water on the air conditioner or it will cause malfunction or electric shock.</p>

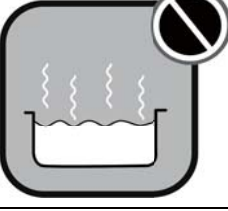
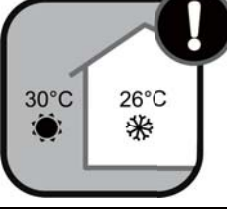
Multi Variable Air Conditioners Compact Cassette Type Indoor Unit

	<p>Do not expose the air conditioner directly to water or place it in a damp or corrosive environment.</p>		<p>Connect power supply 8 hours before operation. Do not disconnect power if you want to stop the unit in a short period of time, e.g. in one night. (This is for protecting the compressor.)</p>
	<p>Volatile liquid like thinner or gasoline will damage the appearance of air conditioner. Please use soft dry cloth or wet cloth with mild detergent to clean the outer case of air conditioner.</p>		<p>During Cooling mode, indoor temperature should not be set too low. Keep the difference between indoor temp and outdoor temp within 5°C.</p>
	<p>If abnormal condition occurs (e.g. unpleasant smell), please turn off the unit at once and disconnect power supply. Then contact AlpicAir service center. If the air conditioner continues to operate despite of abnormal condition, the unit may be damaged and it may cause electric shock or fire hazard.)</p>		<p>Do not repair the air conditioner by yourself. Improper repair will cause electric shock or fire hazard. Please contact AlpicAir service center and have it repaired by professional technicians.</p>

This appliance can be used by children aged from 8 years and above and persons with reduced physical, sensory or mental capabilities or lack of experience and knowledge if they have been given supervision or instruction concerning use of the appliance in a safe way and understand the hazards involved. Children shall not play with the appliance. Cleaning and user maintenance shall not be made by children without supervision.

Install units according to national wiring codes.

If the supply cord is damaged, it must be replaced by the manufacturer or its service agent or a similarly qualified person in order to avoid a hazard.

An all-pole disconnection device which has at least 3mm clearances in all poles, and disconnection must be incorporated in the fixed wiring in accordance with the wiring rules.

Any personal injury or property loss caused by improper installation, improper debug, unnecessary repair or not following the instructions of this manual should not be the responsibility of AlpicAir.

	<p style="text-align: center;">Correct Disposal of this product</p> <p>This marking indicates that this product should not be disposed with other household wastes throughout the E U. To prevent possible harm to the environment or human health from uncontrolled waste disposal, recycle it responsibly to promote the sustainable reuse of material resources. To return your used device, please use the return and collection systems or contact the retailer where the product was purchased. They can take this product for environmental safe recycling.</p>
-------------------------------------------------------------------------------------	-------------------------------------------------------------------------------------------------------------------------------------------------------------------------------------------------------------------------------------------------------------------------------------------------------------------------------------------------------------------------------------------------------------------------------------------------------------------------------------------------------------------------------------------------------------------------------

2 Product Introduction

2.1 Names of Key Components

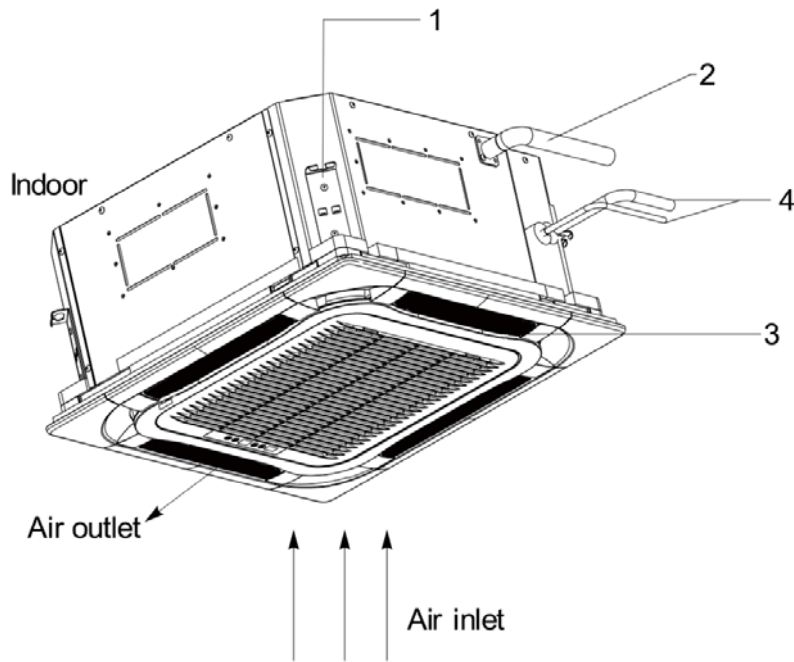

Fig.2.1

No.	1	2	3	4
Name	Drainage device	Drainage Pipe	Air flow flap	Connection Pipe

2.2 Rated Working Condition



	Indoor Side Condition		Outdoor Side Condition	
	Dry Bulb Temp °C	Wet Bulb Temp °C	Dry Bulb Temp °C	Wet Bulb Temp °C
Rated Cooling	27	19	35	24
Rated Heating	20	15	7	6

3 Preparations for Installation







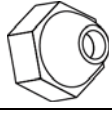
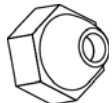



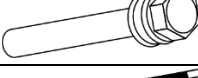

! **NOTE!** This picture is for reference only, please refer to the actual product; the unit of dimension is mm.

3.1 Standard Fittings

Please use the supplied standard fittings listed below as instructed.

No.	Name	Appearance	Q'ty	Usage
1	Remote controller		1+2	To control the indoor unit.
2	Drainage hose assembly		1	To connect the drainage pipe.
3	Special Nut		2	model 15-50
			1	model 56

Multi Variable Air Conditioners Compact Cassette Type Indoor Unit

No.	Name	Appearance	Q'ty	Usage
4	Insulation		1	To insulate the gas pipe.
5	Insulation		1	To insulate the liquid pipe.
6	Flannelette		1	To prevent the communication wire from reaching out the electric raceway.
7	Fastener(300mm)		1	To fasten the sponge.
8	Bolt sub-assy		4	Fix the panel.
9	Corrugated pipe		1	model 56
10	Sponge		4	To insulate the drain pipe.
11	Gasket Mounting Board		1	Used to prevent gasket from falling off.
12	Fastener(200mm)		4	To fasten the sponge.
13	Bolt with Washer		4	To fix the installation paperboard on the unit.
14	Enswathement		2	Used for winding the pipe connecting the indoor and outdoor units.
15	Washer		10	To be used together with the hanger bolt for installing the unit.

3.2 Installation Position Selection

- (1) The location should be able to withstand the weight of unit.
- (2) The water can be drained conveniently from drainage pipe.
- (3) There should be no obstruction near air inlet and air outlet.
- (4) Follow the installation distance required in the Fig. below to ensure sufficient space for maintenance.
- (5) The installation location should be far from heat sources, flammable or explosive gas, or smog spread in the air.
- (6) The appliance shall not be installed in the laundry.
- (7) The indoor unit, outdoor unit, power cord and connection electricity wire should be at least 1m from television and radio in order to prevent interference and noise (Even though 1m distance is ensured, there may be noise if the electric wave is too strong).

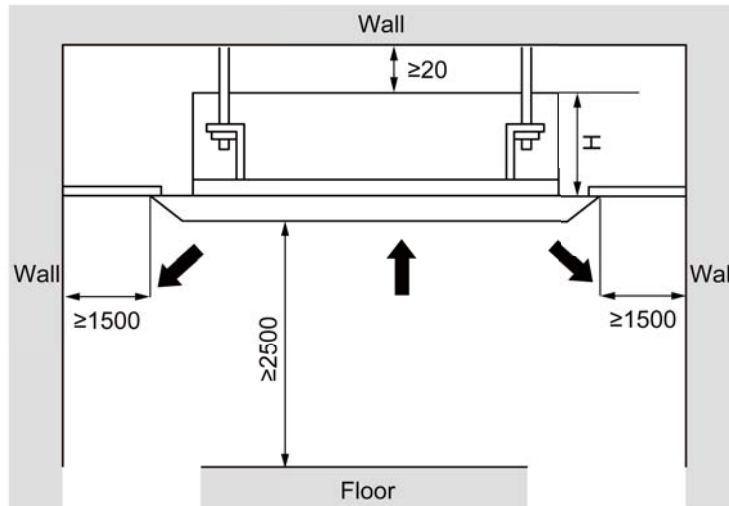

Fig.3.2

Model	H
model 15	305
model 18	305
model 22	305
model 28	305
model 36	305
model 45	305
model 50	305
model 56	305

! NOTES!

- ① The unit shall be installed in accordance with national standards or local regulations.
- ② Only qualified personnel can carry out installation work, please contact with local dealer before installation.
- ③ Make sure all the installation work completed before energizing.

3.3 Requirements of Communication Wire Selection

! NOTE! If air conditioner used under strong electronic-magnetic interference circumstance, STP (shielded twisted pair) communication cable must be adopted.

3.3.1 Select Communication Line for Indoor Unit and Wired Controller

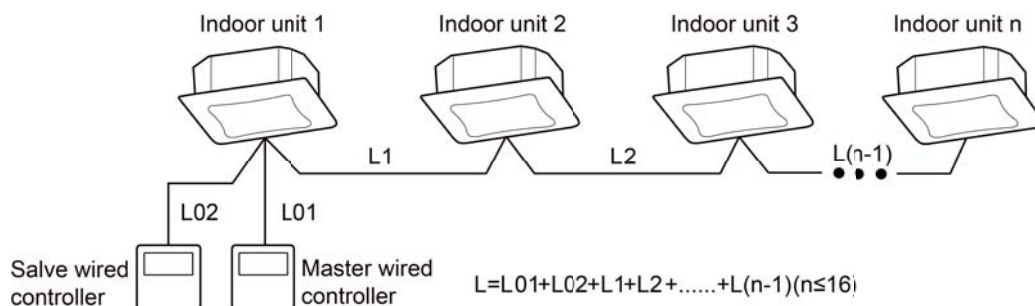

Fig. 3.3.1

Multi Variable Air Conditioners Compact Cassette Type Indoor Unit

Material type	Total length of communication line between indoor unit and wired controller L (m)	Wire size (mm ²)	Material Standard	Remarks
Light/Ordinary polyvinyl chloride sheathed cord. (60227 IEC 52 /60227 IEC 53)	L≤250	2×0.75 ~2×1.25	IEC 60227-5	1. Total length of communication line can't exceed 250m. 2. The cord shall be Circular cord (the cores shall be twisted together). 3. If unit is installed in places with intense magnetic field or strong interference, it is necessary to use shielded wire.

3.3.2 Select Communication Line for Indoor Unit and Outdoor Unit

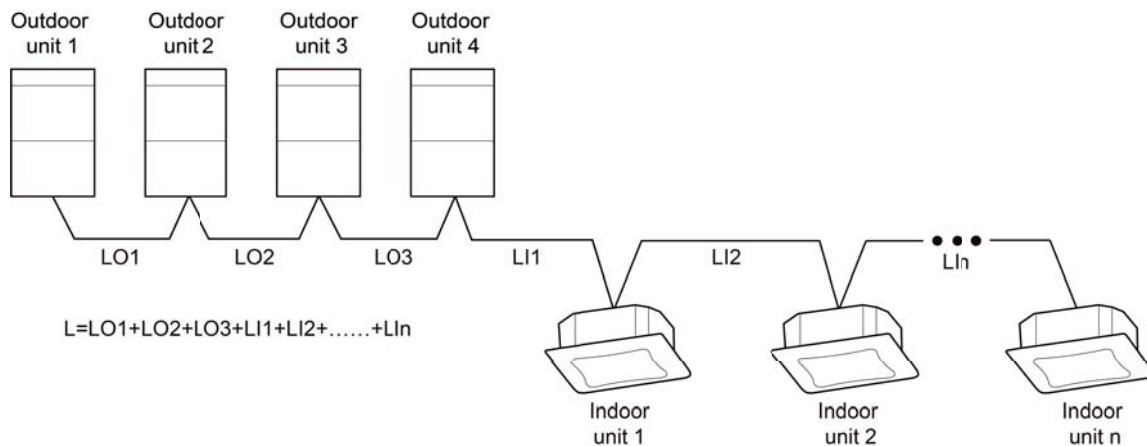

Fig.3.3.2

Material Type	Total Length L (m) of Communication Cable between Indoor Unit and Indoor (Outdoor) Unit	Wire size (mm ²)	Material Standard	Remarks
Light/Ordinary polyvinyl chloride sheathed cord. (60227 IEC 52 /60227 IEC 53)	L≤1000	≥2×0.75	IEC 60227-5	1. If the wire diameter is enlarged to 2×1 mm ² , the total communication line length can reach 1500 m. 2. The cord shall be Circular cord (the cores shall be twisted together). 3. If unit is installed in places with intense magnetic field or strong interference, it is necessary to use shielded wire.

3.4 Wiring Requirements

Dimension of power cord and capacity of air switch.

! NOTES!

- ① The circuit breaker and power cord specification in above sheet are based on max power (max current) of the unit.
- ② The power cord specification in above sheet is based on ambient temperature of 40°C.
- ③ The circuit breaker specification in above sheet is based on ambient temperature of 40°C.
- ④ If the working condition is different, please adjust it according to the specification sheet of circuit breaker.
- ⑤ Supply cords of parts of appliances for outdoor use shall not be lighter than polychloroprene sheathed flexible cord (code designation 60245 IEC 57).

Multi Variable Air Conditioners Compact Cassette Type Indoor Unit

Model	Power Supply	Air Switch Capacity (A)	Minimum Sectional Area of Grounding Wire(mm ²)	Minimum Sectional Area of Power Cord (mm ²)
model 15	220-240V-1ph-50Hz 208-230V-1ph-60Hz	6	1	1
model 18		6	1	1
model 22		6	1	1
model 28		6	1	1
model 36		6	1	1
model 45		6	1	1
model 50		6	1	1
model 56		6	1	1

4 Installation Instructions

4.1 Indoor unit installation

4.1.1 Indoor Unit Dimension and Suspension Bolt Position

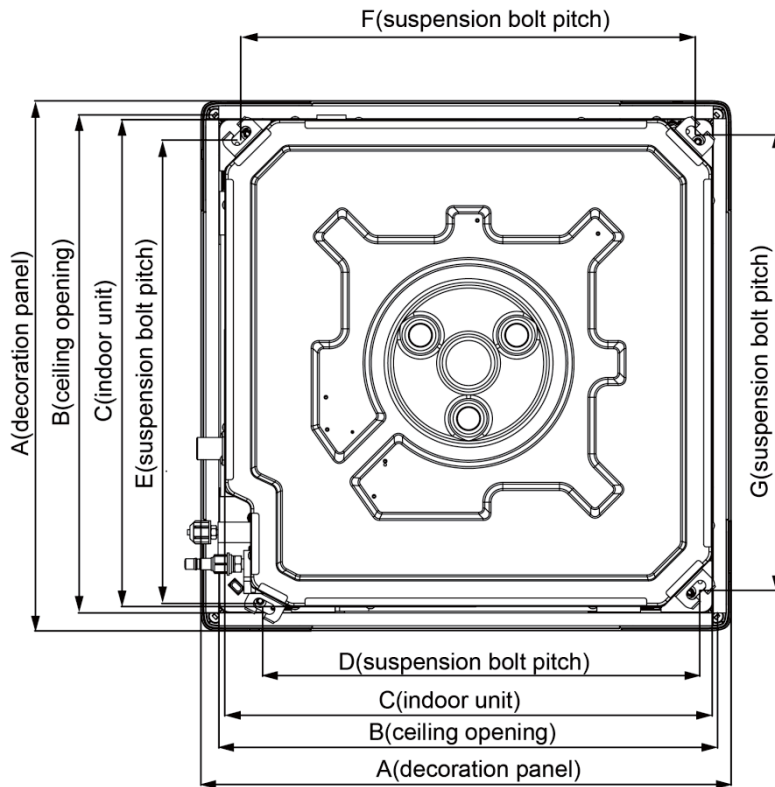

Fig.4.1.1

Below are dimensions of A, B, C, etc. for different models:

Unit: mm

Model	A	B	C	D	E	F	G
model 15	620	580	570	505	550	530	530
model 18							
model 22							
model 28							
model 36							
model 45							
model 50							
model 56							



IMPORTANT! The drilling work and installation of unit must be carried out by qualified personnel.

4.1.2 Suspend the Indoor Unit

(1) Drill bolt holes and install bolts

- 1) Stick the paper pattern on the installation position; drill 4 holes according to the whole site on the cardboard as shown in Fig.4.1.2; diameter of drilling hole is according to the diameter of expansion bolt and the depth is 60-70mm, as shown in Fig.4.1.3.

Unit:mm

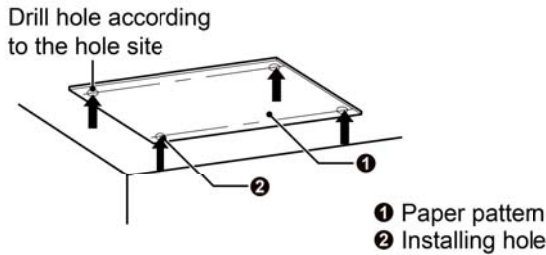

Fig.4.1.2

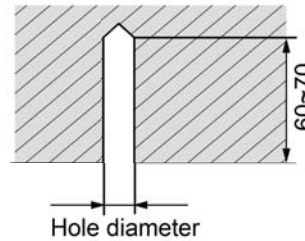

Fig.4.1.3

- 2) Insert the M10 expansion bolt into the hole and then knock the nail into the bolt, as shown in Fig.4.1.4.



NOTE! The length of bolt depends on the installation height of the unit, bolts are field supplied.

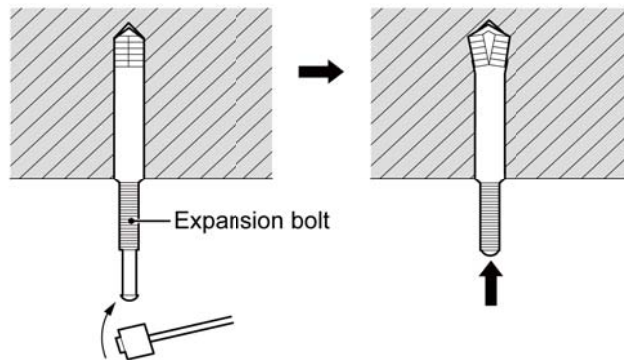

Fig.4.1.4

(2) Install the indoor unit temporarily

Assemble suspension bolt on the expansion bolt, attach the hanger bracket to the suspension bolt. Be sure to fix it securely by using a nut and washer from upper and lower sides of the hanger bracket. The washer fixing plate will prevent the washer from falling.

(3) The usage of paper pattern

Refer to paper pattern of installation for ceiling opening dimension. The center of ceiling opening is indicated on the paper pattern. Fix the paper pattern to the unit with 4 screws and fix the corners of the waterspout at the drainage pipe by screws.

(4) Adjust the unit to the right position.

(5) Check the level of the unit. The indoor unit is equipped with build-in water pump and float switch, verify the levelness of 4 directions by level gauge or vinyl tube (filled with water) respectively.

(6) Remove the washer locating plate and then tighten the nut on it.

(7) Remove the paper pattern.

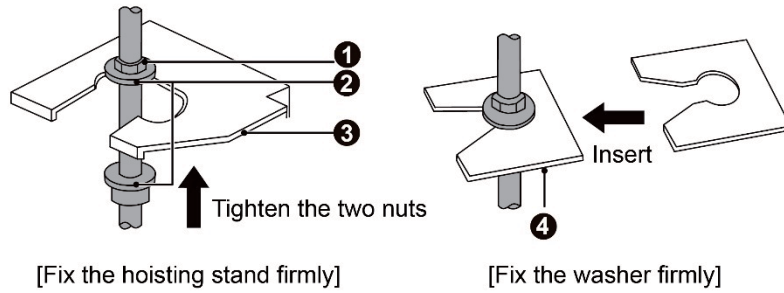

- ① Nut(field supplied)
- ② Washer(provided)
- ③ Hoisting stand
- ④ Washer fixing plate(provided)

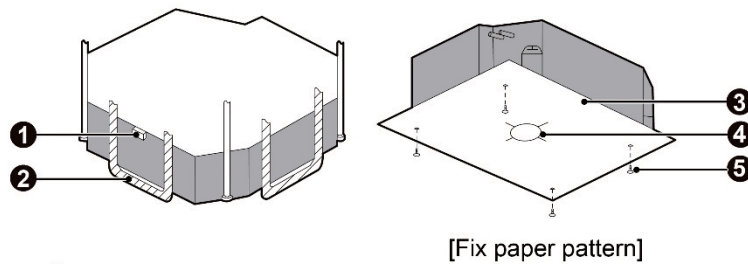

- ① Level meter
- ② PVC pipe
- ③ Paper pattern
- ④ Center of ceiling opening
- ⑤ Screw(provided)

Fig.4.1.5

4.2 Refrigerant Pipe Connection

- (1) Aim the flaring port of copper pipe at the center of screwed joint and then tighten the flaring nut with hand as shown in Fig.4.2.
- (2) Use a torque wrench to tighten up the flaring nut until the wrench gives out a click sound.

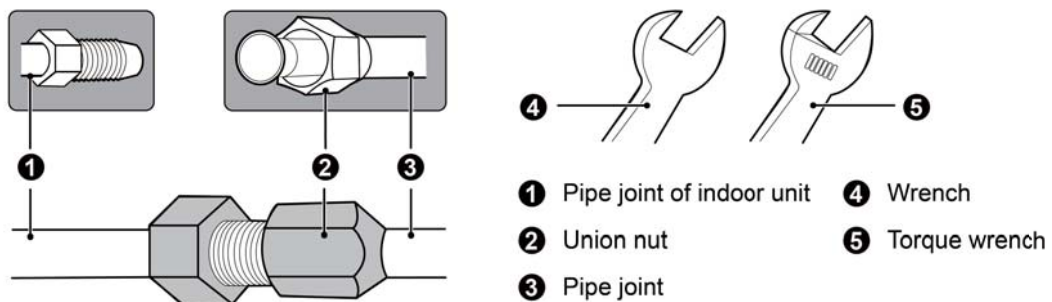

Fig.4.2

Torque for tightening nut	
Pipe diameter (mm)	Torque (N·m)
Φ6.35	15~30
Φ9.52	35~40
Φ12.7	45~50
Φ15.9	60~65
Φ19.05	70~75

- (3) The pipe should not be bent too much or it may crack. Use a pipe bender when bending the pipe.
- (4) Wrap the connection pipe and joint with sponge and then tie them firmly with tape.

4.3 Drainage Pipe Installation and Drainage System Testing

4.3.1 Notice for Installation of Drainage Pipe

- (1) It is not allowed to connect the condensate drain pipe into waste pipe or other pipelines which are likely to produce corrosive or peculiar smell to prevent the smell from entering indoors or corrupt the unit.
- (2) It is not allowed to connect the condensate drain pipe into rain pipe to prevent rain water from pouring in and cause property loss or personal injury.
- (3) Condensate drain pipe should be connected into special drain system for air conditioner.
- (4) The drainage pipe should be short and the gradient downwards should be at least 1%~2% in order to drain condensation water smoothly.
- (5) The diameter of drainage hose should be bigger or equal to the diameter of drainage pipe joint.
- (6) Install drainage pipe according to the following Fig.and arrange insulation to the drainage pipe. Improper installation may lead to water leakage and damp the furniture and other things in the room.
- (7) You can buy normal hard PVC pipe used as the drainage pipe. During connection, insert the end of PVC pipe into the drainage hole and then tighten it with drainage hole and wire binder. Never connect the drainage hole and drainage hose with glue.
- (8) When the drainage pipelines are used for several units, the position of pipeline should be about 100mm lower than the drainage port of each unit. In this case, thicker pipes should be applied.

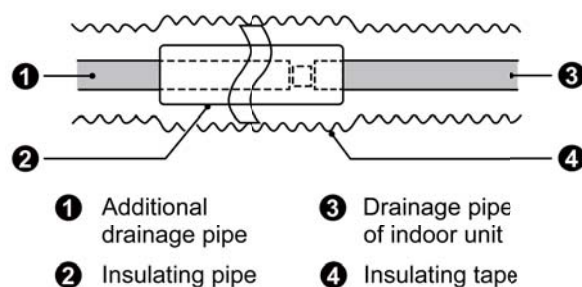

Fig.4.3.1

4.3.2 Installation of Drainage Pipe

- (1) Drainage pipe should have the same diameter or larger diameter than the connection pipes (PVC pipe, outside diameter 25mm, thickness \geq 1.5mm).
- (2) Keep drainage pipe short and sloping downwards at a gradient of at least 1% for preventing forming air bubbles.
- (3) Insert the drainage hose into drain socket and then tighten the metal clamp securely.
- (4) Warp the sealing pad over drainage hose and metal clamp for heat insulation.

- (5) Make sure to perform insulation work for all drainage holes in the room in order to prevent any possible water dropping due to dew condensation.
- (6) Apply the suitable diameter for converging drainage pipe according to the operating capacity of the unit, as show in Fig.4.3.2.1

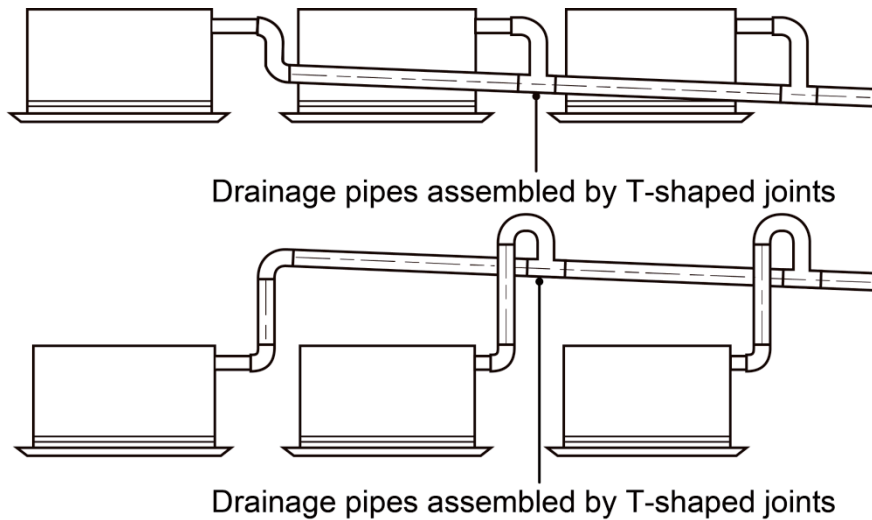

Fig.4.3.2.1

- (7) The horizontal pipe can't be connected to vertical pipe in the same level; please select the connection way as shown in following fig.

NO.1: Three-way connection of drainage pipe joints (Fig.4.3.2.2)

NO.2: Connection of downspout elbow (Fig.4.3.2.3)

NO.3: Inserting horizontal pipe connection (Fig.4.3.2.4)

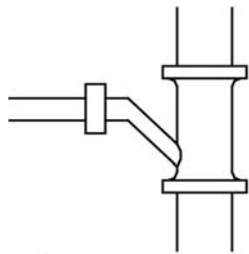

3-way connection of drainage pipe joint

Fig.4.3.2.2

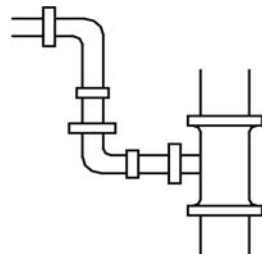

Connection of drain elbow

Fig.4.3.2.3

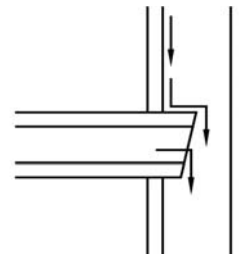

Connection of horizontal pipe

Fig.4.3.2.4

- (8) Drainage pipes should have a downward slope of at least 1%~2%, in order to prevent pipes from sagging; install hanger bracket at intervals of 1000~1500mm.

Unit:mm

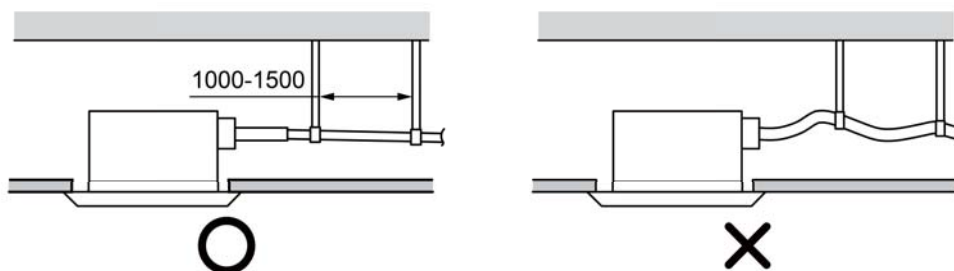
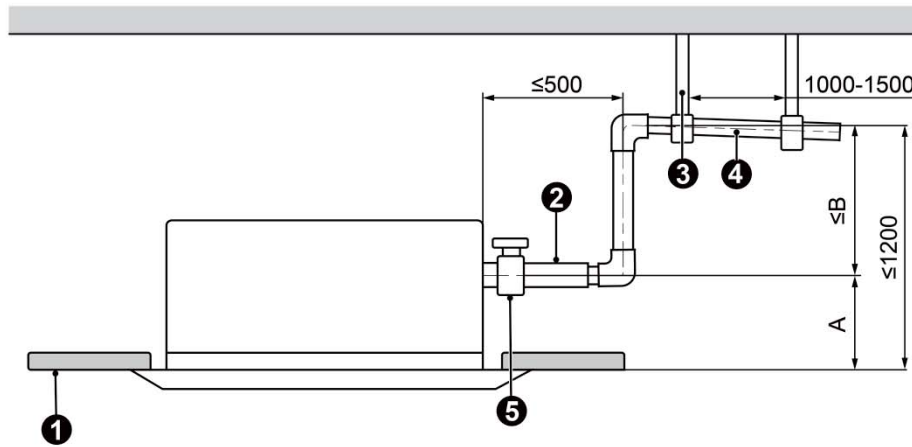

Fig.4.3.2.5

(9) The installation height of raising pipe for drainage should be lower than B. The gradient from raising pipe towards drainage direction should be at least 1%~2%. If the raising pipe is vertical with the unit, the raising height should be less than C, as shown in Fig.4.3.2.6.

Unit:mm



- ① Ceiling
- ② Drain hose(bending is not allowed)
- ③ Hanger bracket
- ④ Drainage pipe
- ⑤ Metal clamp

Fig.4.3.2.6

Unit:mm

Model	A	B	C
model 15	265	935	885
model 18			
model 22			
model 28			
model 36			
model 45			
model 50			
model 56			

4.3.3 Test of Drainage System

(1) Please test drainage system after electric work is finished.

Inject approximately 1L purified water to drain pan from air vent, ensure that not to splash the water over the electrical components (e.g. water pump. etc.).

- 1) In case of commissioning finished, please energize the IDUs and switch to cooling or dry mode, meanwhile, the water pump operates, you can check the draining through the drain socket.
- 2) If communication wire is not connected, communication malfunction "C0" will occur after 60s of energizing. In this case, the water pump operates automatically. Check if the water pump drains normally through drainage port. The water pump will stop automatically after running for 10mins.
- (2) During the test, please carefully check the drainage joint, make sure no any leakage occur.
- (3) It is strongly recommend to do the drain test before ceiling decoration.

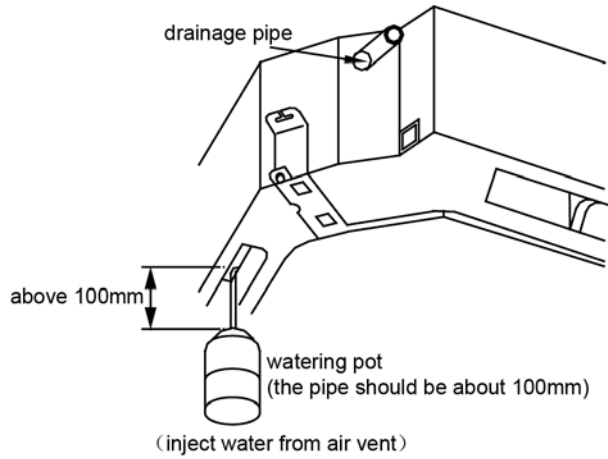

Fig.4.3.3

4.4 Panel Installation

4.4.1 Notices for Installation

- (1) Improper decorative panel installation could cause the following problems.

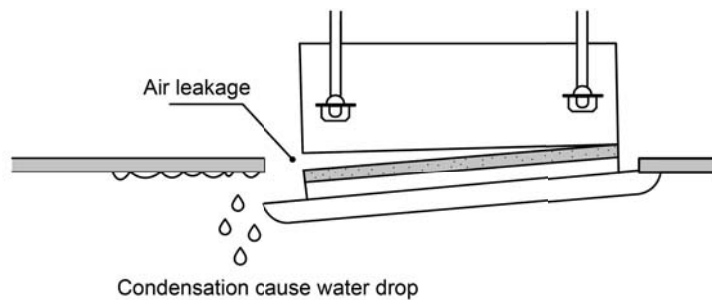

Fig.4.4.1

- (2) Ensure that it's clearance-free between decoration panels and ceiling board after installation, if not, please adjust the body position.

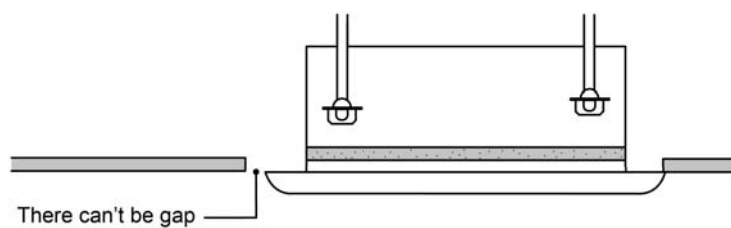

Fig.4.4.2

- (3) Connect the decoration panel terminals (Female) to body terminals (Male) as shown in Fig.4.4.3.

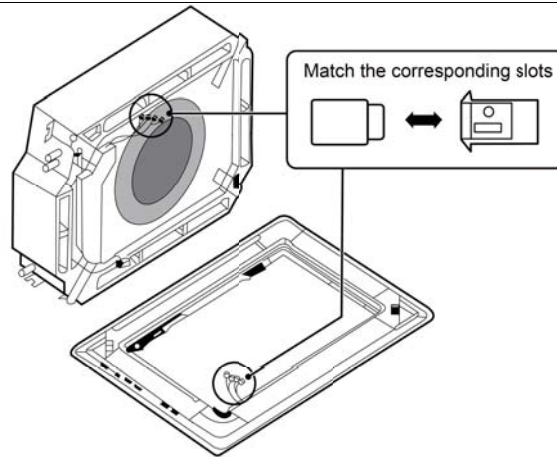

Fig.4.4.3

4.4.2 Panel Installation

- (1) Detach the panel's Corner Cap, there is a mark "piping side" on one of the 4 corners, adjust the panel direction so as to keep the mark and fittings on the same corner, as shown in Fig. 4.4.4

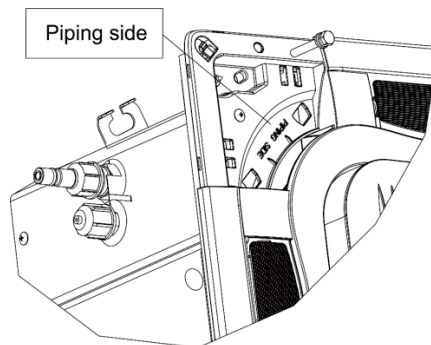

Fig.4.4.4

- (2) Adjust the position of panel to make the panel holes fix at the holes on the units
- (3) Fix the 4 screws at the two side of panel, as shown in Fig.4.4.5.

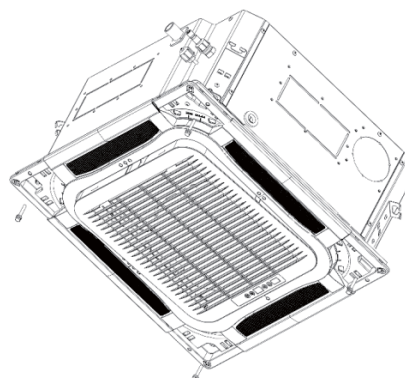

Fig.4.4.5

- (4) Detach the air inlet grille from panel, make a wiring connection of signal receiver. Notices that the connection wire not stuck in the middle of body and panel, or may cause air leakage and lead to condensation water drop.
- (5) Tighten 4 screws at each corner of panel respectively, fix the panel on the body firmly.
- (6) Tighten the screw until the thickness of sealing material between panel and indoor unit is about 5-8mm.

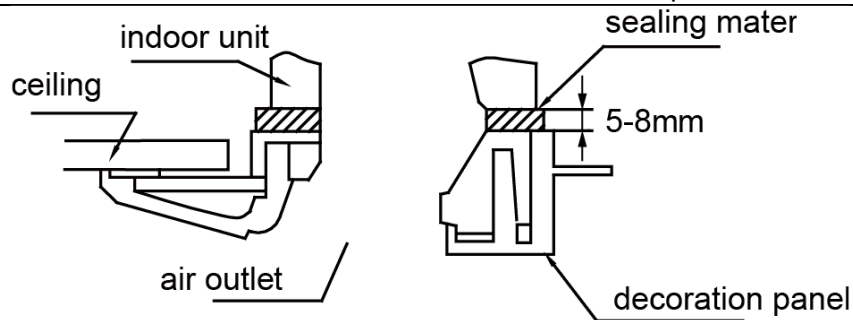

Fig.4.4.6

4.5 Installation of Wired Controller

Wired controller is optional accessory. If wired controller is needed, please contact your local dealer and install the wired controller according to the instruction manual.

! NOTE! Do perform the commissioning operation before first use; automatic addressing or other settings, please refer to the manual of ODU.

5 Wiring Work

! NOTE! Units must be grounded securely, or it may cause electric shock.

- (1) Please carefully read the nameplate and the wiring diagram before carry out the wiring work, incorrect wiring could cause malfunction or even damage the unit.
- (2) The capacity of power supply must be sufficient and the sectional area of wires in the room should be above 2.5mm².
- (3) The unit should be powered by independent circuit and specific socket.
- (4) The wiring should be in accordance with related regulations in order to ensure the units operate reliably.
- (5) Install circuit breaker or branch circuit according to related regulations and electrical standards.
- (6) All wiring must use pressure terminal or single wire. Multi-twisted wire that connects directly to the wiring board may cause fire hazard.
- (7) Keep cable away from refrigerant piping, compressor and fan motor.
- (8) Do not alter the inner wires of air conditioner. Manufacturer does not assume responsibility for damage or abnormal operation due to this reason.
- (9) If the unit is installed in places with strong electromagnetic interference, it's recommended to use twin-twisted shield wire. During wire connection, please pay attention that the metal shield layer of the twin-twisted wire must be grounded (outer case) in order to prevent the unit from electromagnetic interference.
- (10) The communication wires should be separated from power cord and connection wire between indoor unit and outdoor unit.
- (11) If the project needs higher static pressure, you can set it through the wired controller.
- (12) The appliance must be fitted with means for disconnection from the supply mains having a contact separation in all poles that provide full disconnection under overvoltage category III

conditions, and these means must be incorporated in the fixed wiring in accordance with the wiring rules.

5.1 Connection of Wire and Patch Board Terminal

- (1) Connection of single branch wire (as shown in Fig.5.1.1)
 - 1) Use a stripper to strip away about 25 mm of the insulation layer at the end of single branch line so that the single-core wire can be exposed.
 - 2) Remove the wiring screws on the terminal board.
 - 3) Shape the tail of wire into ring by needle nose plier, and keep the gauge of ring in accordance with screw.
 - 4) Lead the screw across the circle of the single branch line and fix it on the wiring board.
- (2) Connection of multi-twisted wire (as shown in Fig.5.1.2)
 - 1) Use a wired stripper to strip away about 10mm of the insulation layer at the end of multi-twisted wire.
 - 2) Loosen the wiring screws on patch board.
 - 3) Use a round terminal fastener or a plier to securely fasten the round terminal with each core wire of the multi-core wire.
 - 4) Confirm the position of each core wire on the round terminal and then use a screwdriver to tighten the terminal screw.

Unit: mm

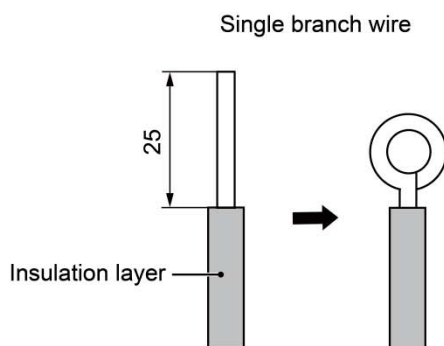

Fig.5.1.1

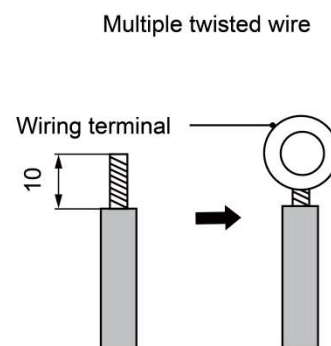

Fig.5.1.2

5.2 Power Cord Connection

! NOTES!

- ① Every unit should be equipped with a circuit breaker for short-circuit and overload protection.
- ② During operation, all indoor units connected to the same outdoor unit system must be kept energized status. Otherwise, the unit can't operate normally.

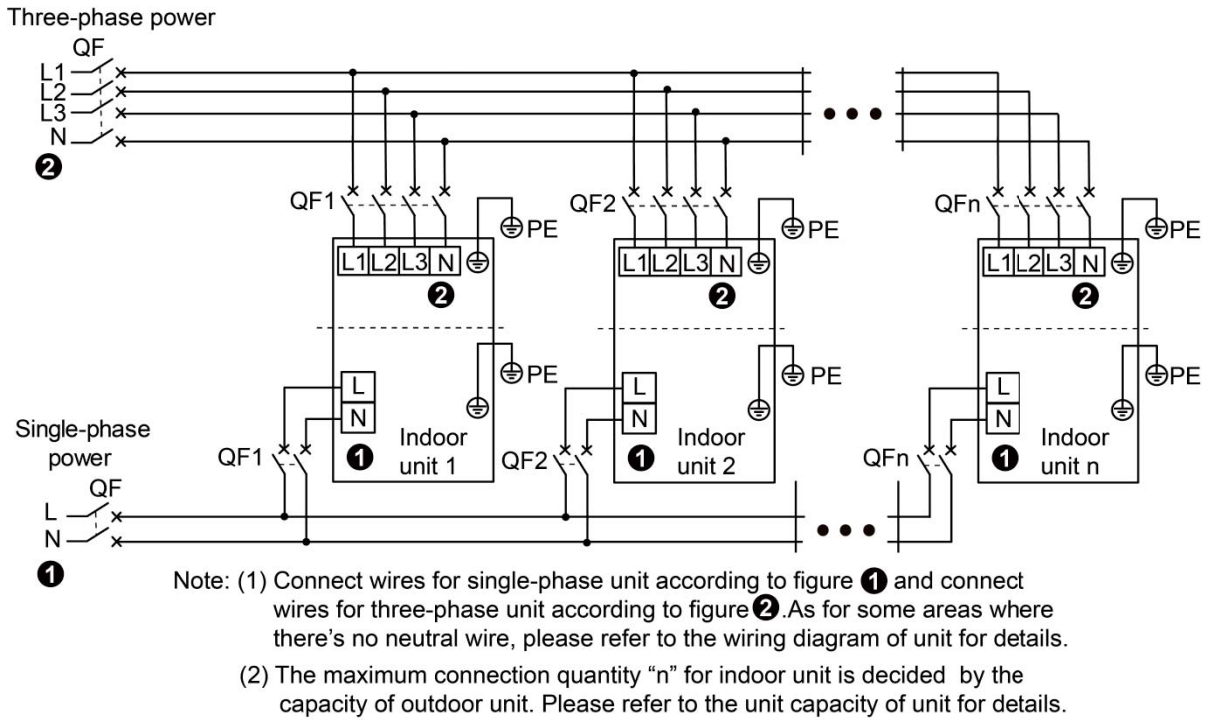

Fig.5.2

- (1) Detach the electric box lid.
- (2) Let the power cord pass through the wiring through-holes.
- (3) Connect wires according to Fig.5.2.
- (4) Fix the power cord with wiring clamp.

5.3 Connection of Communication Wire between Indoor Unit and Outdoor Unit (or indoor unit)

- (1) Detach the electric box cover.
- (2) Let the Communication cable pass through the wiring through-holes.
- (3) Connect the communication wire to terminal D1 and D2 of indoor 4-bit wiring board, as shown in Fig.5.3.1.

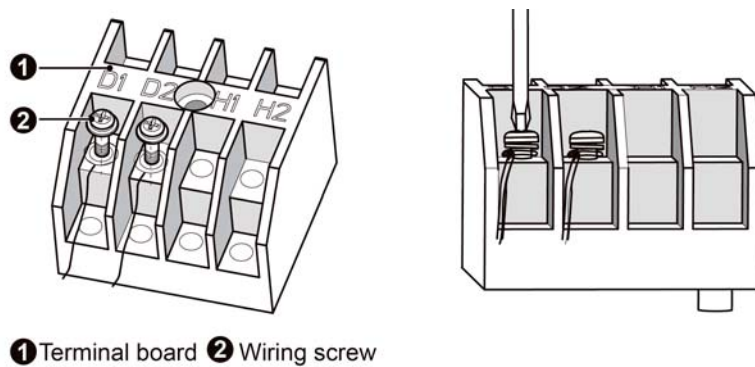

Fig.5.3.1

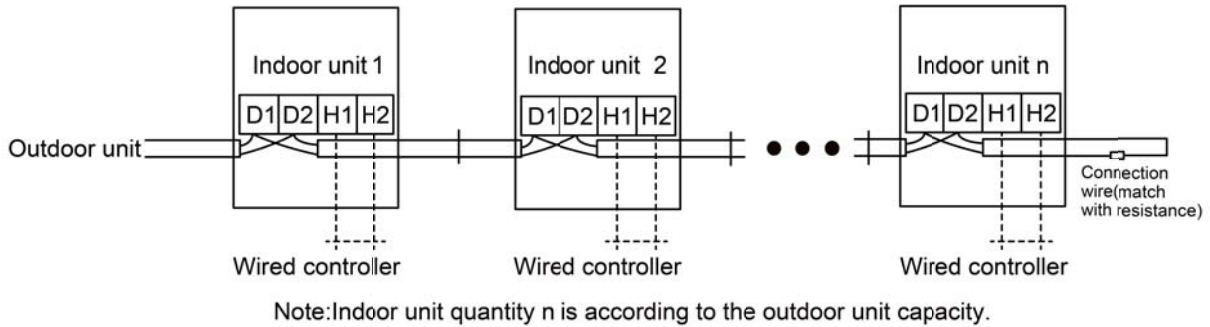

Fig.5.3.2

- (4) Fix the communication cable with clamp of electric box.
- (5) In order to ensure the reliability of communication between IDU and ODU and the communication among each IDU, add a matched resistance (supplied in a package before ex-factory) on the wiring board of the last indoor unit in a series connection. The matched resistance should be connected in parallel between terminal screw D1 and D2, as shown in Fig.5.3.2.

5.4 Connection of Communication Wire for Wired Controller

- (1) Detach the electric box cover.
- (2) Let the communication wire pass through the wiring through-holes.
- (3) Connect the communication wire to terminal H1 and H2 of indoor 4-bit wiring board.
- (4) Fix the communication wire with clamp.
- (5) Wiring instructions of signal receiver and wired controller.
 - 1) Wired controller is shown as Fig.5.4.1, wireless controller is shown as Fig.5.4.2, signal receiver is provided with panel as standard accessory.

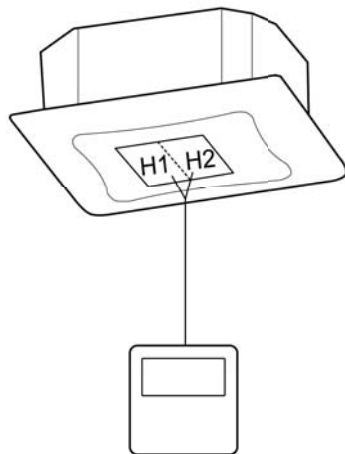

Fig.5.4.1

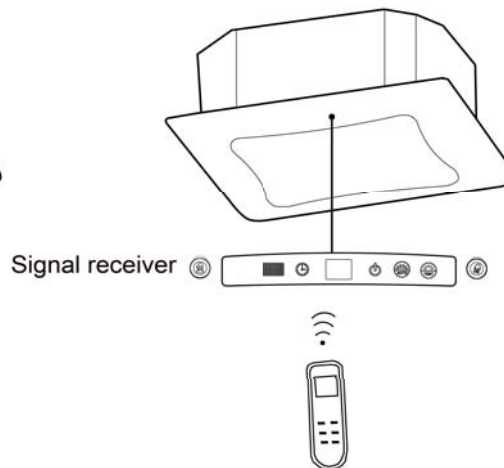

Fig.5.4.2

- 2) Both IDU and wired controller are equipped with signal receiver, and available for wireless control respectively.

5.5 Wiring Instructions of Wired Controller and Indoor Units Network

- (1) Communication wire of indoor unit and outdoor unit (or indoor unit) is connected to D1, D2.

- (2) Wired controller is connected to H1, H2.
- (3) One indoor unit can connect two wired controllers that must be set as master one and slave one.
- (4) One wired controller can control 16 indoor units in maximum at the same time (As shown in Fig.5.5) top using it immediately and contact local service center for assistance.

! NOTES!

- ① The type of indoor units must be the same if they are controlled by the same wired controller.
- ② When the indoor unit is controlled by two wired controllers, the addresses of the two wired controllers should be different through address setting. Address 1 is for main wired controller; Address 2 is for slave wired controller. Detailed setting please refer to the owner's manual of wired controller.

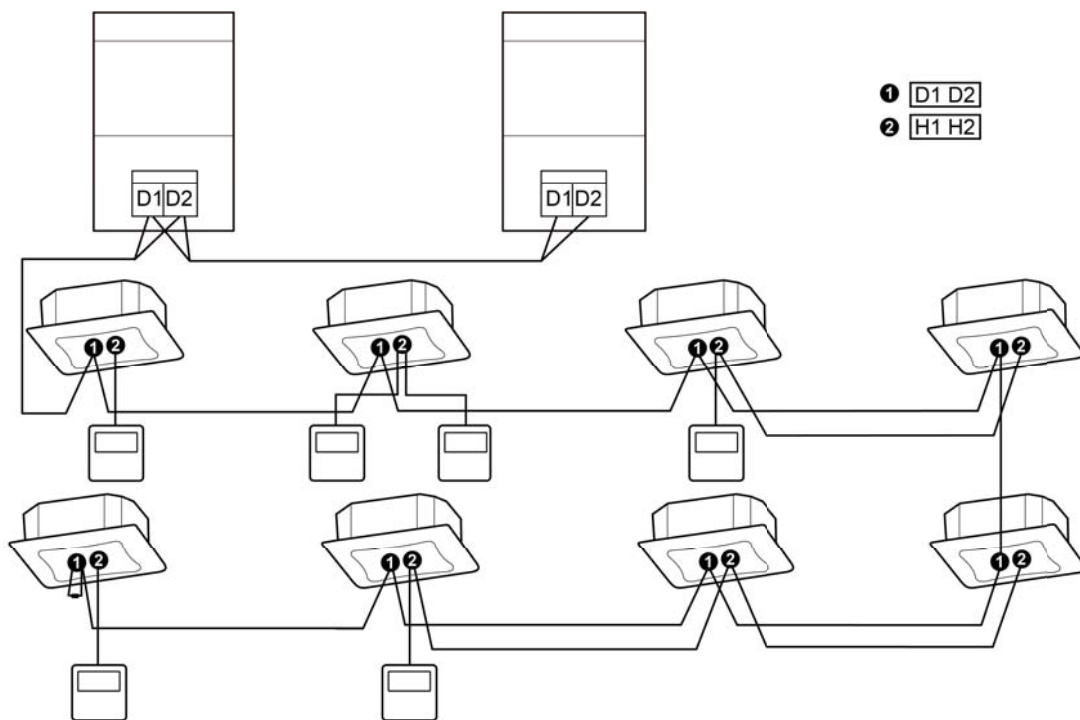

Fig.5.5

6 Routine Maintenance

! WARNING!

- ① Do turn off the unit and cut off the main power supply when cleaning the air conditioner to avoid electric shock or injury.
- ② Stand at solid table when cleaning the unit.
- ③ Do not clean the unit using hot water of over 45°C to prevent the unit from losing color or deforming.
- ④ Do not dry the filters by fire, or it may catch fire or become deformed.
- ⑤ Clean the filter with a wet cloth dipped in neutral detergent.
- ⑥ Please contact after-sales service staff if there is abnormal situation.

6.1 Cleaning of Filter

- (1) Remove the air filter on the air inlet for cleaning. Use a dust catcher or water to clean it. If the filter is very dirty (e.g. greasy), you can clean it using warm water (below 45°C) that is mixed with mild detergent. Then let it dry naturally in cool places.
- (2) If the air conditioner is used in dusty place, please clean the air filter regularly (generally once every 2 weeks).

6.2 Maintenance before the Seasonal Use

- (1) Check if the air inlet and air outlet of indoor and outdoor unit are blocked.
- (2) Check if the grounding wire is in good condition.
- (3) Check if all the power cord and communication cable are securely connected.
- (4) Check if any error code displayed after energized.

6.3 Maintenance after the Seasonal Use

- (1) Set the unit in fan mode for half a day in a sunny day to dry the inner part of unit.
- (2) When the unit won't be used for a long time, please cut off power supply for energy saving, the characters on the wired controller screen will disappear after cutting off the power supply.

7 Table of Error Codes for Indoor Unit

Error Code	Content	Error Code	Content	Error Code	Content
L0	Indoor Unit Error	LA	Indoor Units Incompatibility Error	d9	Jumper Cap Error
L1	Indoor Fan Protection	LH	Low Air Quality Warning	dA	Indoor Unit Network Address Error
L2	E-heater Protection	LC	ODU-IDU Incompatibility Error	dH	Wired Controller PCB Error
L3	Water Full Protection	d1	Indoor Unit PCB Error	dC	Capacity DIP Switch Setting Error.
L4	Wired Controller Power Supply Error	d3	Ambient Temperature Sensor Error	dL	Outlet Air Temperature Sensor Error
L5	Freeze protection	d4	Inlet Pipe Temperature Sensor Error	dE	Indoor Unit CO ₂ Sensor Error
L7	No Master Indoor Unit Error	d6	Outlet Pipe Temperature Sensor Error	dy	Water Temperature Sensor Error
L8	Power Insufficiency Protection	d7	Humidity Sensor Error	C0	Communication Error
L9	Quantity Of Group Control Indoor Units Setting Error	d8	Water Temperature Error	AJ	Filter Cleaning Reminder
db	Special Code: Field Debugging Code				

8 Troubleshooting

The air conditioner is not expected to be serviced by users. Incorrect repair may cause electric shock or fire, so please contact an authorized service center for professional service. The following checks prior to contact may save your time and money.

Phenomenon	Troubleshooting
The unit can't start.	<ul style="list-style-type: none"> ① Power supply is not connected. ② Circuit breaker tripping caused by leakage of electricity. ③ Input voltage is too low. ④ Operation button is closed. ⑤ Control loop is abnormal.
The unit stops after running for a while.	<ul style="list-style-type: none"> ① The inlet or outlet of ODU or IDU are blocked by obstacle. ② Control loop is abnormal. ③ Set the unit in cooling mode when outdoor ambient temperature is higher than 43°C.
Poor cooling effect.	<ul style="list-style-type: none"> ① The filter is dirty or blocked. ② Too heavy heat load of room (e.g. too many people). ③ Door or windows is open. ④ Inlet and outlet of IDU are blocked. ⑤ Setting temperature is too high or refrigerant leaks. ⑥ The performance of room temperature sensor is getting worse.
Poor heating effect.	<ul style="list-style-type: none"> ① The filter is dirty or blocked. ② Door or window is open. ③ Setting temperature is too low. ④ Refrigerant leakage. ⑤ Outdoor ambient temperature is lower than -5°C. ⑥ Abnormality of control circuit.
Indoor fan doesn't start up during heating.	<ul style="list-style-type: none"> ① Placing position of tube temperature sensor head is not suitable. ② Tube temperature sensor head isn't inserted well. ③ Wiring of tube temperature sensor head is broken. ④ Capacitor is leaking electricity.

NOTE!

If air conditioner still fails to work normally after checking and handling as described above, please stop using it immediately and contact local service center for assistance.

